

Rotec Bridas tubuladas

Brida fija tubulada

Drilling Standard: EN1092 PN10, Resin Type: Derakane 411



#	DN (mm)	Pmax (bar)	D (mm)	d6 (mm)	d5 (mm)	r2 (mm)	s4 (mm)	k (mm)	Holes (no.)	d2 (mm)	L1 (mm)	h2 (mm)	b2 (mm)	Article Number
1	15	16	98	15	35	1	4	64	4	14	200	25	12	TFS-15-200/16
2	20	16	116	20	42	1	4	75	4	14	200	25	13	TFS-20-200/16
3	25	16	116	25	50	1	4	85	4	14	250	30	14	TFS-25-250/16
4	32	16	140	32	62	1	5	100	4	18	250	35	15	TFS-32-250/16
5	40	16	150	40	68	1	5	110	4	18	300	40	16	TFS-40-300/16
6	50	16	164	50	82	1	5	125	4	18	300	40	18	TFS-50-300/16
7	50	16	164	50	82	1	5	125	4	18	600	40	18	TFS-50-600/16
8	65	16	184	65	95	1	5	145	4	18	300	50	20	TFS-65-300/16
9	80	16	200	80	111	2	6	160	8	18	300	50	22	TFS-80-300/16
10	80	16	200	80	111	2	6	160	8	18	600	50	22	TFS-80-600/16
11	100	16	220	100	133	2	6	180	8	18	300	55	25	TFS-100-300/16
12	100	16	220	100	133	2	6	180	8	18	600	55	25	TFS-100-600/16
13	125	16	254	125	160	2	6	210	8	18	300	65	27	TFS-125-300/16
14	125	16	254	125	160	2	6	210	8	18	600	65	27	TFS-125-600/16
15	150	16	284	150	188	3	6	240	8	22	300	70	30	TFS-150-300/16
16	150	16	284	150	188	3	6	240	8	22	600	70	30	TFS-150-600/16

Disclaimer

Whilst every care is taken to ensure that the information on this website is complete and accurate, the Rotec Composite Group BV cannot accept responsibility for any omissions or inaccuracies or for any consequences arising therefrom. By using this website, the user accepts the terms of this disclaimer.

17-11-2022

Rotec Bridas tubuladas

Brida fija tubulada

Drilling Standard: EN1092 PN10, Resin Type: Derakane 411

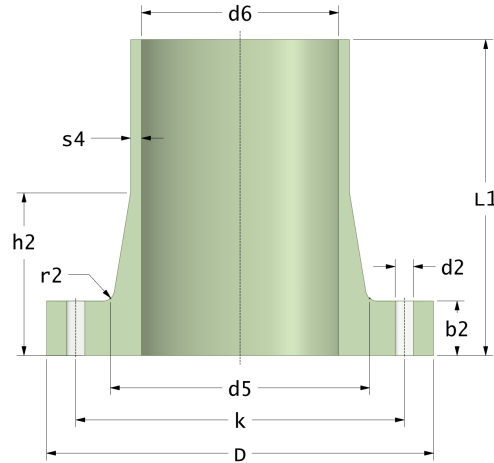

#	DN (mm)	Pmax (bar)	D (mm)	d6 (mm)	d5 (mm)	r2 (mm)	s4 (mm)	k (mm)	Holes (no.)	d2 (mm)	L1 (mm)	h2 (mm)	b2 (mm)	Article Number
17	200	10	342	200	237	4	6	295	8	22	360	85	33	TFS-200-360/10
18	200	10	342	200	237	4	6	295	8	22	600	85	33	TFS-200-600/10
19	250	10	395	250	293	5	7	350	12	22	360	100	37	TFS-250-360/10
20	250	10	395	250	293	5	7	350	12	22	600	100	37	TFS-250-600/10
21	300	10	445	300	342	6	7	400	12	22	360	115	42	TFS-300-360/10
22	300	10	445	300	342	6	7	400	12	22	600	115	42	TFS-300-600/10
23	350	10	505	350	398	7	8	460	16	22	360	135	45	TFS-350-360/10
24	400	10	565	400	451	8	8	515	16	26	360	150	48	TFS-400-360/10
25	400	10	565	400	451	8	8	515	16	26	600	150	48	TFS-400-600/10
26	450	10	640	450	539	8	9	565	20	26	360	160	52	TFS-450-360/10
27	500	10	670	500	556	8	9	620	20	26	360	180	56	TFS-500-360/10
28	500	10	670	500	556	8	9	620	20	26	600	180	56	TFS-500-600/10
29	600	10	780	600	647	8	9	725	20	30	360	210	64	TFS-600-360/10
30	600	10	780	600	647	8	9	725	20	30	600	210	64	TFS-600-600/10

Disclaimer

Whilst every care is taken to ensure that the information on this website is complete and accurate, the Rotec Composite Group BV cannot accept responsibility for any omissions or inaccuracies or for any consequences arising therefrom. By using this website, the user accepts the terms of this disclaimer.

17-11-2022